

Relaxed under pressure

Pressure Reducing Valve Type 582
Pressure Retaining Valve Type 586



Your added value is our first priority

We listen to our customers' needs and we understand what the process requirements are - and in developing our new valves, we took both into consideration. A compelling feature of our innovative pressure regulating valves is their completely reengineered design. By reducing the outer geometry, we have accommodated a key customer request for compactness - without restricting performance in any way.

+ Strong on details

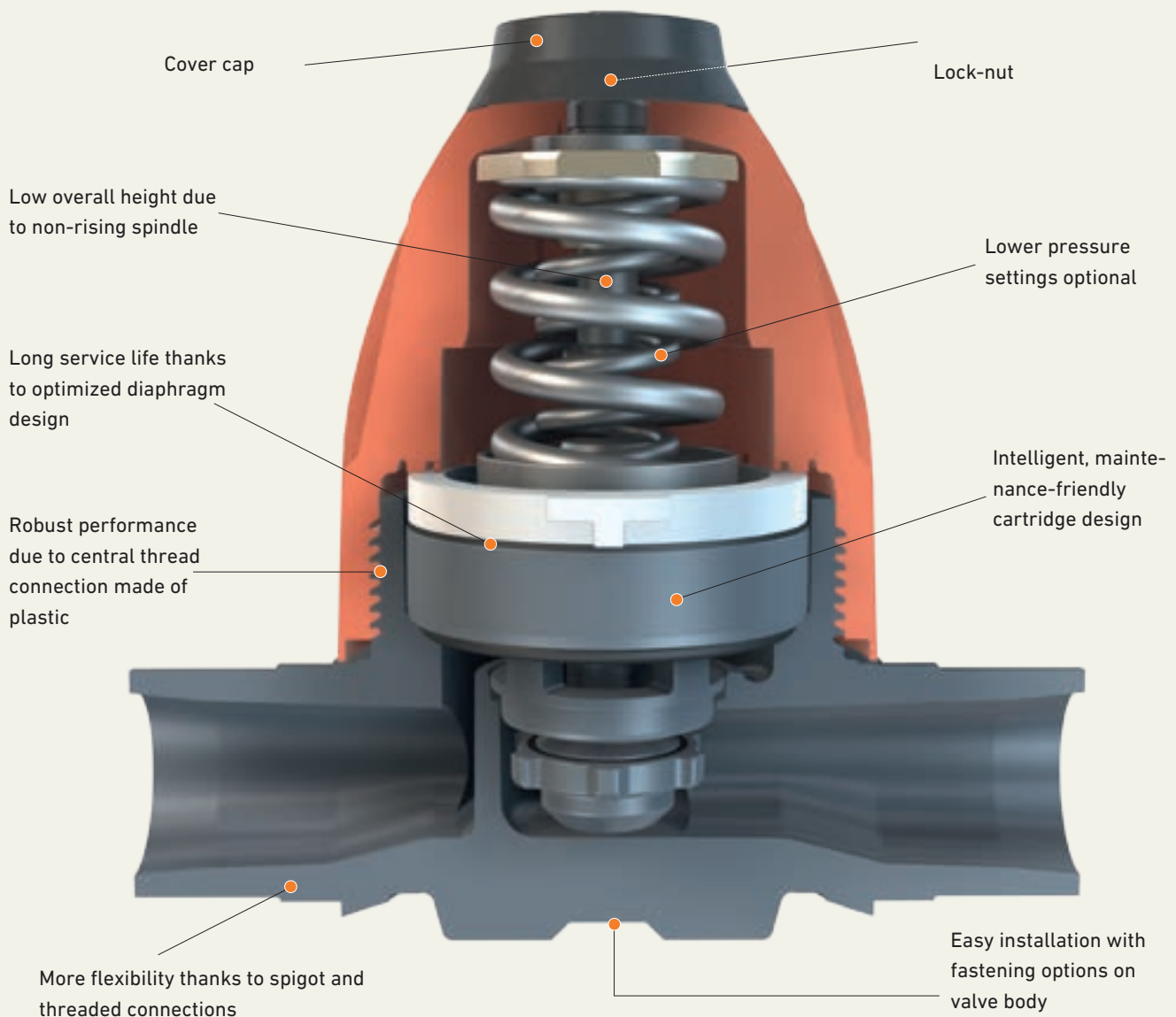

Our compact pressure regulating valves for precise regulation in your applications.

No matter whether the application requires system pressure to be reduced or retained. Maximum performance with minimal space requirement is what we promise.

+ Easy, reliable and flexible



Safer operation with less maintenance

- More precise and reliable pressure control over long periods of time
- No retightening metal screws thanks to central screw connection, in addition to homogenous thermal expansion behavior
- Corrosion-free plastic union with no exposed metal parts
- For use in high-purity applications, elastomer-free piston design, produced in a class 1000 clean room



Intelligent and modular design

- Replaceable cartridge for easy maintenance
- Pressure reducing and retaining valves available with or without manometer
- Pressure gauges on both sides of valve possible (installation in any position)
- Maximum space-saving due to non-rising spindle



Intuitive and easy operation

- Easily adjusted actuation unit (set screw)
- Injection-molded flow arrow to indicate direction of flow
- Injection-molded direction arrow on valve housing to indicate pressure increase/ decrease adjustment
- Simple manometer installation; brass manometer as standard or for highly aggressive media complete with gauge guard for media separation

It's your choice

A modular system that provides you with maximum flexibility. With unions available, our pressure regulating valves are adaptable to any standard or material. Easily replaceable cartridges facilitate maintenance and spare parts inventory.

+ Simply more options

PVC-U



PVC-C

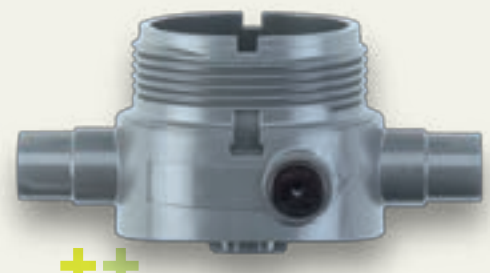



Optional manometer with adapter for media separation.



Snap elements to indicate valve type and sealing material.



Integrated fastening bush for safer valve fastening.

PP



PVDF



Constant outlet pressure

Pressure reducing valves, often referred to as pressure control valves, ensure that the pressure at the valve outlet remains constant. They are used wherever a higher system pressure needs to be reduced to a pre-defined value. Depending on the application, fluctuating pressures are evened out or devices branching out from the main pipeline are protected against excessive pressure. For use in high-purity systems, a special version of the valve is available with an elastomer-free piston.

+ Pressure reducing valve type 582



You want to control your processes easily and reliably.

Which is why we have developed a pressure reducing valve which you can depend on and which is easy to handle.

+ Exactly controlled pressure

Dimensions	DN 10-50 (3/8" - 2")
Materials	PVC-U, PVC-C, PP-H, PVDF
Diaphragms	EPDM/ PTFE
Seals	EPDM, FPM
Connections	Unions, spigots
Pressure rating (nominal pressure)	PN 10
Pressure setting range	0.5 - 9 bar, 0.3 - 3 bar (7 - 130 psi, 4 - 44 psi)
Hysteresis	max. 0.5 bar (max. 7 psi)



Function

The pressure on the valve outlet side acts via the diaphragm on the adjusting spring. By means of the spring preload, which is adjusted via the set screw on the valve, an equilibrium of forces is established. If the outlet pressure rises above the set value, the piston is lifted against the spring force. The valve closes and the outlet pressure is reduced. If the outlet pressure falls below the set value, the piston is pressed down by the spring force. The valve begins to open until a state of equilibrium is reestablished. Irrespective of a rising or falling inlet pressure, the outlet pressure remains largely constant because it is not directly correlated to the inlet pressure.

Constant inlet pressure

Pressure retaining valves, also known as overflow valves, ensure that the pressure at the valve inlet remains constant. They are used wherever the system pressure needs to remain constant or a defined counterpressure needs to be generated against feed pumps. It balances out pressure pulsation and reduces pressure peaks. If the valve is installed on the branch of a T-fitting, it can be used as an overflow or relief valve.

+ Pressure retaining valve type 586



You want to control your processes efficiently.

+ Maintain pressure reliably

Function

By means of adjustable spring force, the desired pressure is set in the valve inlet. If the inlet pressure rises above the set value, e.g. due to excessive delivery rate of the pump, the valve piston is lifted against the spring force. As a result, the valve opens and the pressure in the outlet pipe is reduced. If the pressure in the inlet pipe falls, the spring force presses the piston down toward the valve seat and closes the valve as soon as the inlet pressure sinks below the preset spring tension. In this way, a constant pressure in the inlet pipe is maintained.



This is why we have developed a new pressure retaining valve that contributes to the energy and cost efficiency of your processes.

Dimensions	DN 10-50 (3/8" - 2")
Materials	PVC-U, PVC-C, PP-H, PVDF
Diaphragms	EPDM/ PTFE
Seals	EPDM, FPM
Connections	Unions, spigots
Pressure rating (nominal pressure)	PN 10
Pressure setting range	0.5 - 9 bar, 0.3 - 3 bar (7 - 130 psi, 4 - 44 psi)
Hysteresis	max. 0.5 bar (max. 7 psi)



Produced in the clean room

Special, elastomer-free piston design
for your high-purity applications.





Specifications

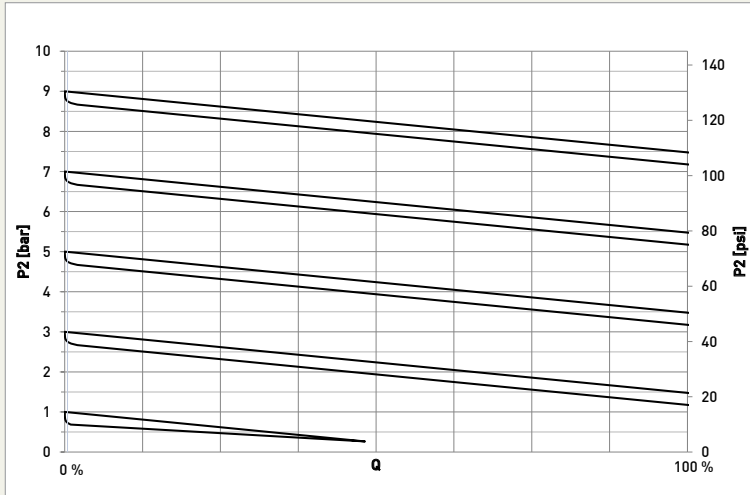

Hysteresis curve
Pressure reducing valve type 582
100 % corresponds to a flow velocity of 2 m/s (6.6 ft/s).

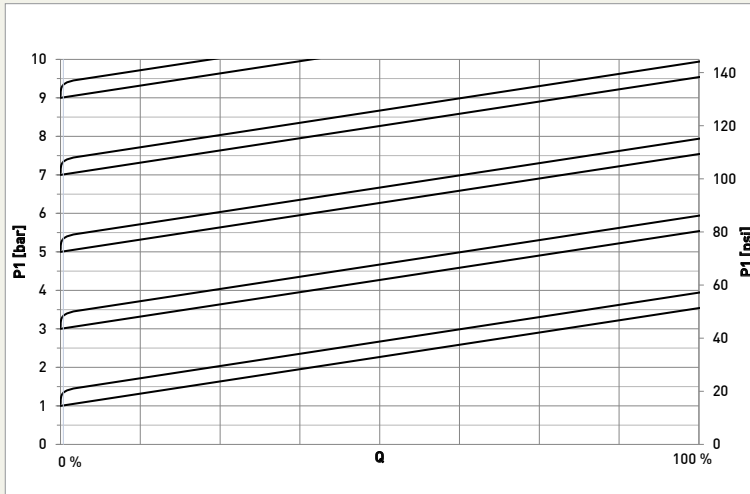

Hysteresis curve
Pressure retaining valve type 586
100 % corresponds to a flow velocity of 2 m/s (6.6 ft/s).

Type 582

Size	100 %	
16DN10 (3/8")	1000 l/h	4.4 gpm
20DN15 (1/2")	1600 l/h	7.0 gpm
25DN20 (3/4")	2500 l/h	11.0 gpm
32DN25 (1")	4000 l/h	17.6 gpm
40DN32 (1 1/4")	6000 l/h	26.4 gpm
50DN40 (1 1/2")	10000 l/h	44.0 gpm
63DN50 (2")	16000 l/h	70.4 gpm

On the left, you see the schematic diagram of the hysteresis curve. The corresponding table shows the maximum values at 100 % in the diagram.

Type 586

Size	100 %	
16DN10 (3/8")	1000 l/h	4.4 gpm
20DN15 (1/2")	1600 l/h	7.0 gpm
25DN20 (3/4")	2500 l/h	11.0 gpm
32DN25 (1")	4000 l/h	17.6 gpm
40DN32 (1 1/4")	6000 l/h	26.4 gpm
50DN40 (1 1/2")	10000 l/h	44.0 gpm
63DN50 (2")	16000 l/h	70.4 gpm

On the left, you see the schematic diagram of the hysteresis curve. The corresponding table shows the maximum values at 100 % in the diagram.

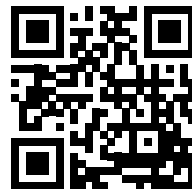

Take advantage of our new online calculation tool to get the best dimensioning of your valve.

+ Flow characteristics and technical details

Hysteresis curve

The hysteresis curves illustrated to the left result from opening and closing the valve. They show the setting range of 0.5 - 9.0 bar (7-130 psi). The values apply to water at 20 °C (68 °F) and a flow velocity of 2 m/s (6.6 ft/s).

Pressure-temperature diagram

The pressure/temperature curves are valid for applications with water or aqueous media, working temperature 20 °C (68 °F), service life 25 years and a design factor C = 2.

P permissible pressure in bar, psi T temperature in °C (Celsius), °F (Fahrenheit)

582 Pressure reducing valve

DN (mm)	inch	d (mm)	Kv 100		Cv100 (gpm)
			(L/min)	(L/h)	
10	3/8	16	45	2700	3.1
15	1/2	20	48	2850	3.3
20	3/4	25	112	6700	7.7
25	1	32	129	7730	8.9
32	1 1/4	40	254	15240	17.5
40	1 1/2	50	293	17590	20.2
50	2	63	319	19170	22.0

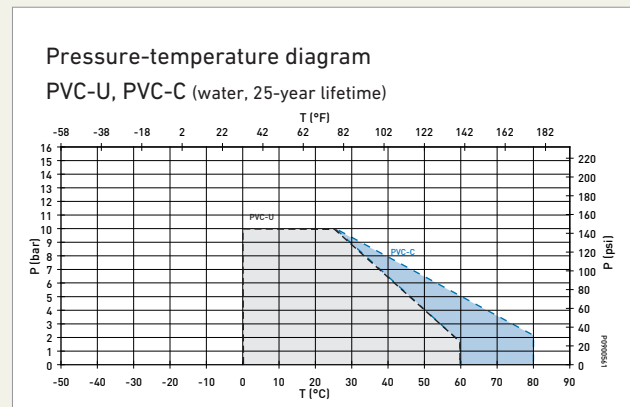

586 Pressure retaining valve

DN (mm)	inch	d (mm)	Kv 100		Cv100 (gpm)
			(L/min)	(L/h)	
10	3/8	16	50	3020	3.5
15	1/2	20	53	3150	3.6
20	3/4	25	114	6840	7.9
25	1	32	125	7500	8.6
32	1 1/4	40	263	15760	18.1
40	1 1/2	50	286	17140	19.7
50	2	63	293	17610	20.2

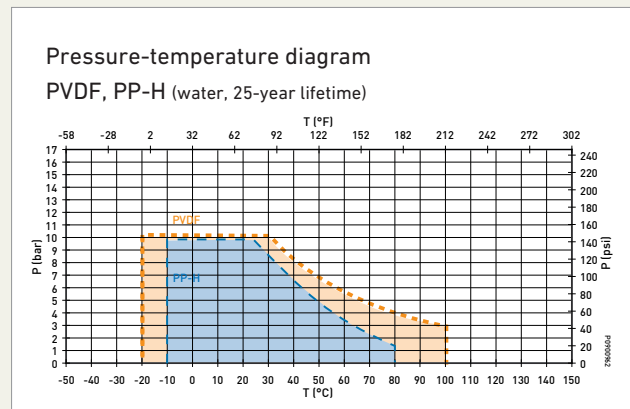

Kv100 at pressure differential p = 1 bar
Cv100 at pressure differential p = 1 psi

As individual as your applications, as diverse as your requirements.

We have been engineering application-oriented system solutions successfully in plastic for over 50 years. We offer individual, comprehensive systems and single components for a variety of applications and media. The further development of our portfolio is a crucial success factor for us and our customers. Our new pressure regulating valves have impressed users in the most diverse applications, thanks to their innovative outer geometry and specific material properties.

+ Versatile in use



- 1 • Water distribution lines
- House connections and service lines
- Waste water piping

- 2 • Industrial applications
- Mining applications

- 3 • Recreational facilities
- Golf courses
- Campsites

- 4 • Agriculture
- Hot-houses
- Irrigation systems

Water Treatment

Drinking water, industrial water, waste water: Depending on the area of application, our customers face diverse challenges in water treatment. These range from ensuring a specific water quality to the precise dosing of chemicals. The fact that our pressure regulating valves are corrosion-free and exhibit good flow characteristics make them ideal for water treatment applications.

Microelectronics

Since the processes and products in the microelectronic industry are highly sensitive, they require highly specialized systems and controlled clean room conditions. Stringent demands are made on the purity of the water used and how this ultrapure water is transported. Our pressure reducing

valves with special, elastomer-free pistons are resistant to abrasion and ideally suited for regulating high-purity media.

Chemical Process Industry

Aggressive media and harsh application conditions are a reality in many of the processes in the chemical industry. The piping systems and components implemented must therefore comply with the highest requirements in terms of safety and durability. Manufactured of highly chemical-resistant plastics, our pressure regulating valves are the right choice in demanding chemical applications as well.

Your decision

We make selecting the right products as simple as possible

We offer you an ideal combination of personal support and technical planning tools. With our online tools you have an overview of all the decisive criteria for optimal valve selection: e.g. chemical resistance tables to determine the right material for your application or calculation tools for layout and dimensioning.



With our practical online tool, you can find the right product for your application quickly and easily. For more information:

www.gfps.com/prv

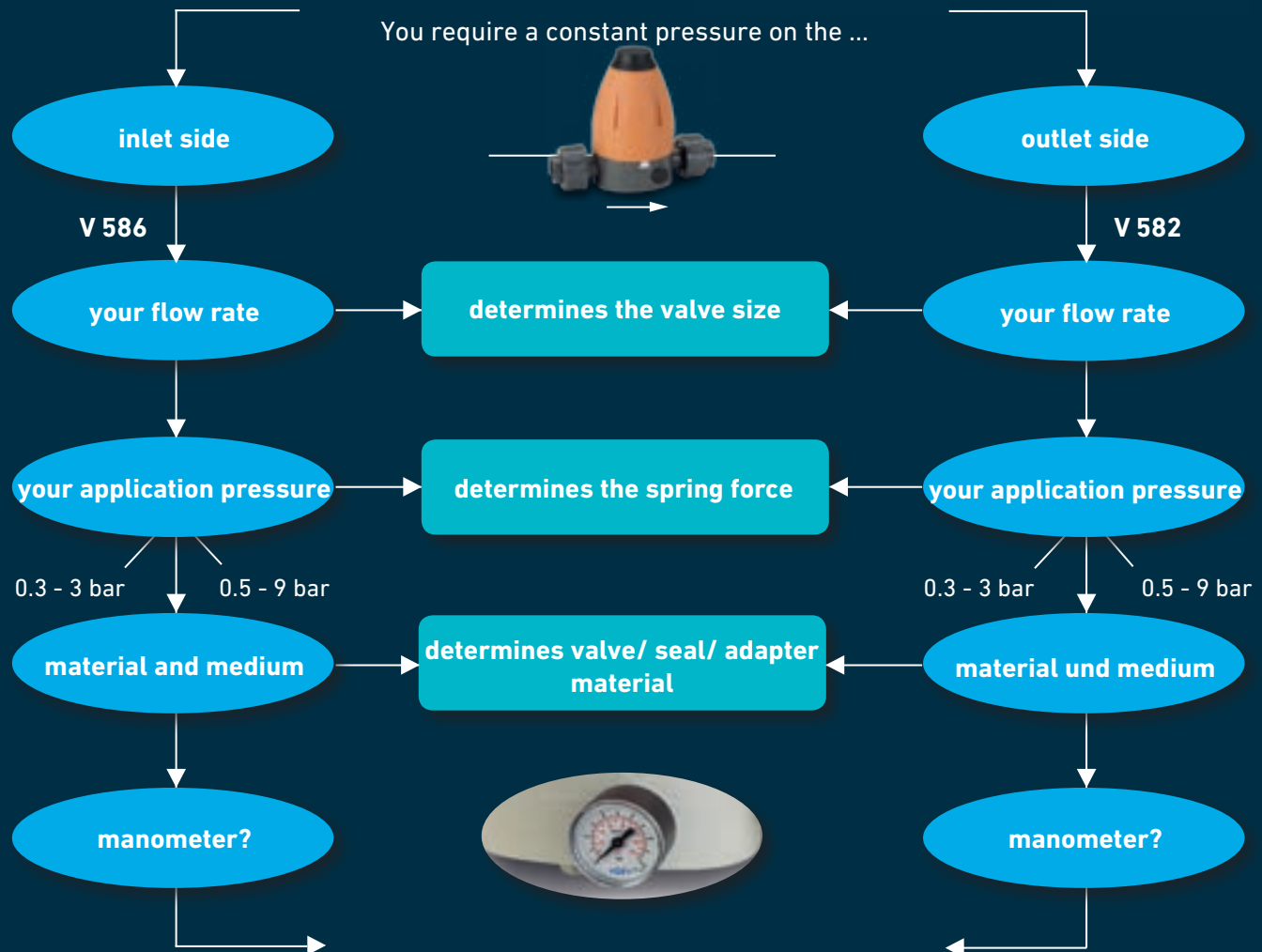

Pressure regulating valves available with manometer optionally on both sides

+GF+

Worldwide at home

Our sales companies and representatives ensure local customer support in over 100 countries

www.gfps.com

Argentina / Southern South America

Georg Fischer Central Plastics
Sudamérica S.R.L.
Buenos Aires, Argentina
Phone +54 11 4512 02 90
gfcentral.ps.ar@georgfischer.com
www.gfps.com/ar

Australia

George Fischer Pty Ltd
Riverwood NSW 2210 Australia
Phone +61 (0) 2 9502 8000
australia.ps@georgfischer.com
www.gfps.com/au

Austria

Georg Fischer
Rohrleitungssysteme GmbH
3130 Herzogenburg
Phone +43 (0) 2782 856 43-0
austria.ps@georgfischer.com
www.gfps.com/at

Belgium / Luxembourg

Georg Fischer NV/SA
1070 Bruxelles/Brüssel
Phone +32 (0) 2 556 40 20
be.ps@georgfischer.com
www.gfps.com/be

Brazil

Georg Fischer Sist. de Tub. Ltda.
04795-100 São Paulo
Phone +55 (0) 11 5525 1311
br.ps@georgfischer.com
www.gfps.com/br

Canada

Georg Fischer Piping Systems Ltd
Mississauga, ON L5T 2B2
Phone +1 (905) 670 8005
Fax +1 (905) 670 8513
ca.ps@georgfischer.com
www.gfps.com/ca

China

Georg Fischer Piping Systems Ltd
Shanghai 201319
Phone +86 21 3899 3899
china.ps@georgfischer.com
www.gfps.com/cn

Denmark / Iceland

Georg Fischer A/S
2630 Taastrup
Phone +45 (0) 70 22 19 75
info.dk.ps@georgfischer.com
www.gfps.com/dk

Finland

Georg Fischer AB
01510 VANTAA
Phone +358 (0) 9 586 58 25
Fax +358 (0) 9 586 58 29
info.fi.ps@georgfischer.com
www.gfps.com/fi

France

Georg Fischer SAS
95932 Roissy Charles de Gaulle Cedex
Phone +33 (0) 1 41 84 68 84
fr.ps@georgfischer.com
www.gfps.com/fr

Germany

Georg Fischer GmbH
73095 Albershausen
Phone +49 (0) 7161 302-0
info.de.ps@georgfischer.com
www.gfps.com/de

India

Georg Fischer Piping Systems Ltd
400 076 Mumbai
Phone +91 224007 2001
branchoffice@georgfischer.com
www.gfps.com/in

Indonesia

George Fischer Pte Ltd –
Representative Office
Phone +62 21 2900 8564
Fax +62 21 2900 8566
sgp.ps@georgfischer.com
www.gfps.com/sg

Italy

Georg Fischer S.p.A.
20063 Cernusco S/N (MI)
Phone +39 02 921 861
it.ps@georgfischer.com
www.gfps.com/it

Japan

Georg Fischer Ltd
556-0011 Osaka,
Phone +81 (0) 6 6635 2691
jp.ps@georgfischer.com
www.gfps.com/jp

Korea

GF Piping Systems
Georg Fischer Korea Co., Ltd.
Unit 2501, U-Tower
120 HeungdeokJungang-ro (Yeongdeok-dong)
Giheung-gu, Yongin-si, Gyeonggi-do, Korea
Phone: +82 31 8017 1450
Fax: +82 31 217 1454
kor.ps@georgfischer.com
www.gfps.com/kr

Malaysia

George Fischer (M) Sdn. Bhd.
40460 Shah Alam, Selangor Darul Ehsan
Phone +60 (0) 3 5122 5585
Fax +603 5122 5575
my.ps@georgfischer.com
www.gfps.com/my

Mexico / Northern Latin America

Georg Fischer S.A. de C.V.
Apodaca, Nuevo Leon
CP66636 Mexico
Phone +52 (81) 1340 8586
Fax +52 (81) 1522 8906
mx.ps@georgfischer.com
www.gfps.com/mx

Middle East

Georg Fischer
Piping Systems (Switzerland) Ltd
Dubai, United Arab Emirates
Phone +971 4 289 49 60
gcc.ps@georgfischer.com
www.gfps.com/int

Netherlands

Georg Fischer N.V.
8161 PA Epe
Phone +31 (0) 578 678 222
nl.ps@georgfischer.com
www.gfps.com/nl

Norway

Georg Fischer AS
1351 Rud
Phone +47 67 18 29 00
no.ps@georgfischer.com
www.gfps.com/no

Philippines

George Fischer Pte Ltd
Representative Office
Phone +632 571 2365
Fax +632 571 2368
sgp.ps@georgfischer.com
www.gfps.com/sg

Poland

Georg Fischer Sp. z o.o.
05-090 Sekocin Nowy
Phone +48 (0) 22 31 31 0 50
poland.ps@georgfischer.com
www.gfps.com/pl

Romania

Georg Fischer
Piping Systems (Switzerland) Ltd
020257 Bucharest - Sector 2
Phone +40 (0) 21 230 53 80
ro.ps@georgfischer.com
www.gfps.com/int

Russia

Georg Fischer
Piping Systems (Switzerland) Ltd
Moscow 125047
Phone +7 495 258 60 80
ru.ps@georgfischer.com
www.gfps.com/ru

Singapore

George Fischer Pte Ltd
11 Tampines Street 92, #04-01/07
528 872 Singapore
Phone +65 6747 0611
Fax +65 6747 0577
sgp.ps@georgfischer.com
www.gfps.com/sg

Spain / Portugal

Georg Fischer S.A.
28046 Madrid
Phone +34 (0) 91 781 98 90
es.ps@georgfischer.com
www.gfps.com/es

Sweden

Georg Fischer AB
117 43 Stockholm
Phone +46 (0) 8 506 775 00
info.se.ps@georgfischer.com
www.gfps.com/se

Switzerland

Georg Fischer
Rohrleitungssysteme (Schweiz) AG
8201 Schaffhausen
Phone +41 (0) 52 631 30 26
ch.ps@georgfischer.com
www.gfps.com/ch

Taiwan

Georg Fischer Co., Ltd
San Chung Dist., New Taipei City
Phone +886 2 8512 2822
Fax +886 2 8512 2823
www.gfps.com/tw

United Kingdom / Ireland

Georg Fischer Sales Limited
Coventry, CV2 2ST
Phone +44 (0) 2476 535 535
uk.ps@georgfischer.com
www.gfps.com/uk

USA / Caribbean

Georg Fischer LLC
9271 Jeronimo Road
92618 Irvine, CA
Phone +1 714 731 88 00
Fax +1 714 731 62 01
us.ps@georgfischer.com
www.gfps.com/us

Vietnam

Georg Fischer Pte Ltd
Representative Office
136E Tran Vu, Ba Dinh District, Hanoi
Phone +84 4 3715 3290
Fax +84 4 3715 3285
sgp.ps@georgfischer.com
www.gfps.com/sg

International

Georg Fischer
Piping Systems (Switzerland) Ltd
8201 Schaffhausen/Switzerland
Phone +41 (0) 52 631 30 03
Fax +41 (0) 52 631 28 93
info.export@georgfischer.com
www.gfps.com/int

The technical data are not binding. They neither constitute expressly warranted characteristics nor guaranteed properties nor a guaranteed durability. They are subject to modification. Our General Terms of Sale apply.

